

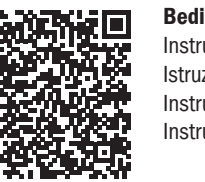

Projection alarm clock with WIFI VIEW SHOW



Cat.-No. 35.8002.01
The complete manual can be downloaded from www.tfa-dostmann.de/en/service/downloads/instruction-manuals.



Bedienungsanleitung
Instruction manual
Istruzioni per l'uso
Instrucciones de uso
Instrukcja obsługi

Mode d'emploi
Gebruiksaanwijzing
Bruksanvisning
Návod k použití

Vielen Dank, dass Sie sich für dieses Gerät aus dem Hause TFA entschieden haben.

Bevor Sie mit dem Gerät arbeiten: Lesen Sie sich bitte die Bedienungsanleitung genau durch.
Die Bedienungsanleitung liegt dem Gerät bei oder zum Download unter www.tfa-dostmann.de/service/downloads/anleitungen

Beachten Sie besonders die Sicherheitshinweise! Bewahren Sie die Bedienungsanleitung gut auf!

Thank you for choosing this instrument from TFA.

Before you use this product: Please make sure you read the instruction manual carefully.
The instruction manual is enclosed with the device or can be downloaded at www.tfa-dostmann.de/en/service/downloads/instruction-manuals

Please take particular note of the safety advice!
Please keep this instruction manual safe for future reference.

Nous vous remercions d'avoir choisi l'appareil de la société TFA.

Avant d'utiliser votre appareil : Veuillez lire attentivement le mode d'emploi.
Le mode d'emploi est joint à l'appareil ou peut être téléchargé à l'adresse suivante www.tfa-dostmann.de/en/service/downloads/instruction-manuals

Suivez bien toutes les consignes de sécurité ! Conservez soigneusement le mode d'emploi !

Vi ringraziamo per aver scelto l'apparecchio della TFA.

Prima di utilizzare l'apparecchio: Leggete attentamente le istruzioni per l'uso.
Le istruzioni per l'uso sono allegate all'apparecchio o possono essere scaricate da www.tfa-dostmann.de/en/service/downloads/instruction-manuals

Prestate particolare attenzione alle misure di sicurezza!
Conservate con cura le istruzioni per l'uso.

Hartelijk dank dat u voor dit apparaat van de firma TFA hebt gekozen.

Voordat u met het apparaat gaat werken: Leest u a.u.b. de gebruiksaanwijzing aandachtig door.
De gebruiksaanwijzing is bij het apparaat gevoegd of kan worden gedownload van www.tfa-dostmann.de/en/service/downloads/instruction-manuals

Volg in elk geval de veiligheidsinstructies op! De gebruiksaanwijzing goed bewaren a.u.b.!

Muchas gracias por haber adquirido este dispositivo de TFA.

Antes de utilizar el dispositivo: Lea detenidamente las instrucciones de uso.
Las instrucciones de uso se adjuntan al dispositivo o pueden descargarse de www.tfa-dostmann.de/en/service/downloads/instruction-manuals

Tenga en cuenta ante todo las advertencias de seguridad.
Guarde las instrucciones de uso en un sitio seguro.

Tack för att du väljer detta instrument från TFA.

Innan du använder den här produkten: Var god se till att du läser igenom bruksanvisningen noggrant.
Bruksanvisningen följer med enheten eller kan laddas ner på www.tfa-dostmann.de/en/service/downloads/instruction-manuals

Vänligen ta särskild hänsyn till säkerhetsråden!
Vänligen förvara denna instruktionsbok säkert för framtida referens!

Děkujeme, že jste si vybrali výrobek značky TFA.

Před použitím: Následující instrukce k použití čtěte velmi pozorně.
Návod k použití je přiložen u zařízení nebo je možné si ho stáhnout z www.tfa-dostmann.de/en/service/downloads/instruction-manuals

Dbejte zvýšené pozornosti bezpečnostním pokynům. Uchovejte si manuál pro případ budoucího použití.

Dziękujemy, że zdecydowali się Państwo na to urządzenie firmy TFA.

Zanim zaczniecie Państwo użytkować to urządzenie: prosimy zapoznać się dokładnie z instrukcją obsługi.
Instrukcja obsługi jest załączona do urządzenia lub może zostać pobrana ze strony: www.tfa-dostmann.de/en/service/downloads/instruction-manuals

Przestrzegajcie szczególnie zasad bezpieczeństwa !
Zachowujcie instrukcję obsługi w dobrym stanie!

Step 1 | Power up the projection alarm clock

Power up the projection alarm clock

- Connect the attached power adapter to the projection alarm clock.
- Remove the battery insulation strip at the bottom of the projection alarm clock.

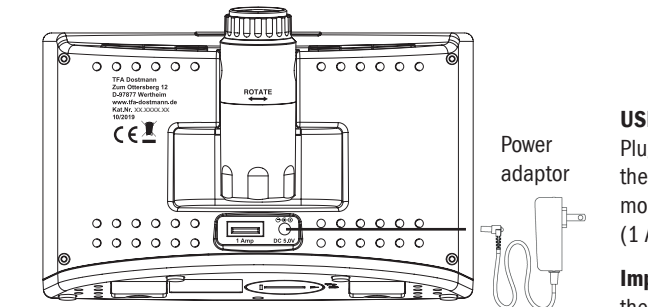

Operation as projection alarm clock without Internet connection

When you set up the projection alarm clock for the first time, the default alarm time, comfort level and moon phase are displayed.

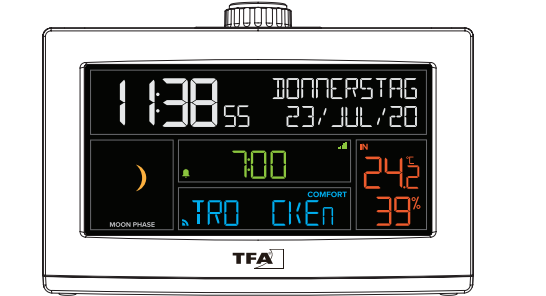

Display without Internet connection

USB charging function

Plug a suitable USB cable into the USB port on the alarm clock and connect the other end to your mobile device. Make sure that the charging rate (1 Amp) is suitable for your mobile device.

Important! The charging function only works with the power adapter.

Operation as projection alarm clock with Internet connection

Once you have connected the projection alarm clock to the app and the internet, the display will change and you will see the extended display.

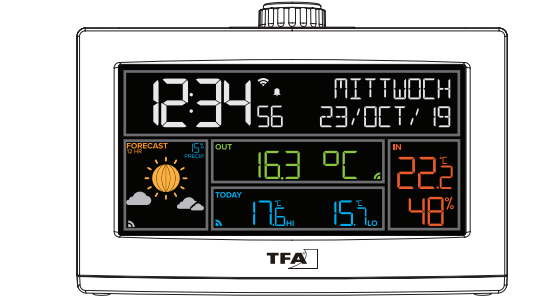

Display with Internet connection

Step 2 | Connect the projection alarm clock to the Internet and the TFA VIEW App (optional)

Download
Download the free TFA VIEW App from the "Apple App Store" or "Google Play Store".



Launch software
Open the TFA VIEW App and follow the on-screen instructions.

Get your projection alarm clock ready
Ensure your projection alarm clock Wi-Fi symbol is flashing. If it is not, press and hold the + and - button at the same time until the symbol begins flashing. Your alarm clock is now ready to connect to the Internet and the TFA VIEW App.

Having trouble connecting to the Wi-Fi?
First make sure that your mobile device on which you have installed the VIEW App is connected to the 2.4 GHz network of your Wi-Fi router and that you have entered the correct password for your Wi-Fi.

For details on how to connect to your router's 2.4 GHz network, refer to your router documentation.

For more troubleshooting tips and support visit: www.tfa-dostmann.de/en/service/frequently-asked-questions/

Legal information:
Google Play and the Google Play logo are trademarks of Google LLC. App Store and the Apple logo are trademarks of Apple Inc.

Overview of the functions of your VIEW projection alarm clock with and without Internet connection

Function	Standalone	Connected
Adjustable projection	✓	✓
Adjustable snooze interval	✓	✓
Alarm setting via TFA VIEW App		✓
Nap-Timer	✓	✓
Room climate (temperature + humidity)	✓	✓
Indication of the comfort level (Dry - wet - OK)	✓	
12 - hour forecast (forecast values from weather service)		✓
Moon phase	✓	
Automatic time and calendar setting via Internet		✓
Forecast of the highest and lowest values, outdoor temperature		✓
Propability of precipitation in %		✓
Possibility to retrieve further transmitters	✓	✓
Additional weather information and personalized messages		✓
Retrieval of measured values via TFA VIEW app		✓

Step 3 | Basic settings without Internet functions (optional)

Setting mode

- Press and hold the **SET** button for 3 seconds to enter the setting mode.
- Press + or - button to make the desired setting.
- Confirm with the **SET** button and go to the next setting.

Important! Press the **SNOOZE/LIGHT** button to quit the setting mode at any time.

Sequence of setting mode: Key tone on/off > 12/24 hours mode > hours > minutes > year > month > day > temperature setting °C/°F

Important! If you have connected the projection alarm clock to the app and the Internet, the time and date are set automatically.

Forecast values

If the projection alarm clock is connected to the app and the Internet, the TFA View SHOW offers you additional weather forecast values free of charge and without additional subscription. This function includes the following forecast values that can be shown on the display:

12 - hour weather forecast | daily highest and lowest values | rainfall probability | current outdoor temperature

Important display symbols

Wi-Fi symbol
Flashes when the projection alarm clock is ready to connect to the Wi-Fi, the Internet and the app, and is static when the projection alarm clock is connected.

Internet - symbol
Is shown in certain areas of the display and indicates when measured or predicted values are received from the Internet.

Batterie - symbol
Is displayed individually for the projection alarm clock and the connected transmitters (optional) and indicates when the battery in the projection alarm clock (backup battery) or the corresponding transmitter need to be changed.

Transmitter symbol
Tells you the reception strength of the connection between the transmitters (optional) and the projection alarm clock. The symbol flashes when the projection alarm clock is in transmitter search mode.

Alarm symbol
Indicates that a wake-up alarm is on.

Alarm settings

- Press and hold the **ALARM** button and the hour indicator will be flashing.
- Press the **+** or **-** button to adjust the hours.
- Press the **ALARM** button again and you can adjust the minutes with the **+** or **-** button.
- Press the **ALARM** button again. You can now set the snooze interval in steps of 5 minutes.
- Press the **ALARM** button again. The settings are now saved and the alarm is activated.

Activate and deactivate the alarm

Press the ALARM button to show the alarm time. Press the **ALARM** button to activate or deactivate the alarm.

If the alarm is activated the alarm symbol  will appear on the display.

When the alarm is sounding, press any button (except **SNOOZE/LIGHT**) to stop the alarm. The alarm remains active.

Snooze function

When the alarm is ringing, press the **SNOOZE/LIGHT** button and the snooze function with the adjusted interval will be activated. The time display counts down until the next alarm. Press any button (except **SNOOZE/LIGHT**) to stop the snooze function.

Buttons and their functions

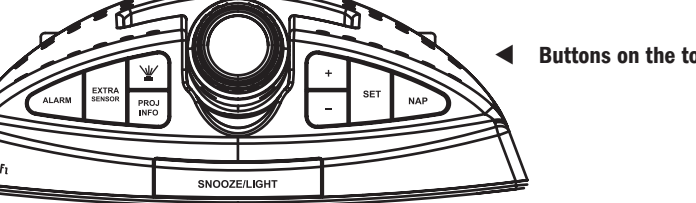

Buttons on the top



ALARM	Press briefly to activate/deactivate the alarm function. Press and hold to set the alarm time.
EXTRA Sensor	Press briefly to select optional transmitters. Press and hold to add optional transmitters.
	Press briefly to adjust the brightness of the projection.
PROJ INFO	Press briefly to adjust the setting options of the projection. Press and hold to set an automatic change of the projection display.
+ or - + and -	Press + or - button to make the desired settings, or press and hold both buttons together to look for the Wi-Fi signal.
SET	Press and hold the button to enter the setting mode. Press the button briefly to display the Wi-Fi status.
NAP	Press the button briefly to activate the nap function, press and hold the button to set the duration of the nap function.
SNOOZE/LIGHT	Press the button to adjust the brightness of the display. Press and hold the button to adjust the auto dimming mode.
ALARM + NAP	Press and hold both buttons to reset your device to factory settings.

Add transmitters

Whether you choose to connect to the Internet and the TFA View app or not, the alarm clock has the ability to display data for up to 4 transmitters.

For a complete list of all compatible stations and transmitters, please visit www.tfa-dostmann.de/view/.

Connect additional transmitters to your station:

- Press and hold the **EXTRA SENSOR** button until the transmitter symbol  is flashing.
- Insert the batteries in the transmitter you wish to add. If the transmitter  **TX** button, press it to force a transmission signal.
- Your transmitter should connect within the next 3 minutes, briefly displaying its ID and type. The transmitter symbol changes from flashing back to static display.
- Press the **EXTRA SENSOR** button to switch between the displays of each transmitter.
- To add more transmitters or devices to the TFA VIEW App, go to the App menu in the section **Add / Change** then tap on **Device** and then tap on **Add Device**. Finally, please scan the code of the new transmitter or device.

Important! When first powering up, or after a factory restart, transmitters which have already been activated are automatically connected to the base station.

Projection options

Select projection

Press briefly the **PROJ INFO** button to toggle between the following displays:

- Current time /standard)
- Indoor temperature and humidity
- Current outdoor temperature (must be connected to Wi-Fi)
- Display of additional transmitters (only if an additional transmitter is connected to the projection alarm clock)

Projection angle

Set the projection arm to the respective position.

Rotation of the projection

Rotate the bottom of the projection arm to customize the the rotation angle of your projected image up to 270°

Brightness of the projection

Press the button  briefly to adjust the brightness of the projection.

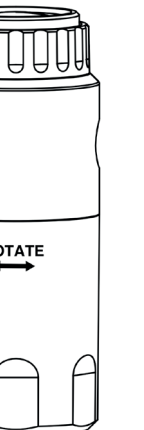

Projection arm

Specifications

Base station

Measuring range - temperature: 0°C ... +50°C (+32°F ... +99.9°F)
 Measuring range - humidity: 10% ... 99% RH
 Precision: Temperature (± 1°), humidity (± 5%)
 Power supply: Power adapter (included), backup batteries (1x CR2032, included)
 USB charging socket on the rear: Output current max. 1 A
 Input power adapter: 100-240 V~, 50/60 Hz, 0.5A Max
 Output power adapter: 5 V~, 1.5A, 7.5W

Average active efficiency: ≥76.65%
 No-load power consumption: ≤ 0.1 W
 Transmission frequency: 868 MHz
 Maximum radio-frequency power: < 25mW
 Transmission range : 100m (open field)

Wi-Fi requirements

Wi-Fi transmission frequency : 2.4 GHz (802.11 b/g/n)
 Network name / network password: Must not exceed 45 characters
 Network speed: Minimum 1 Mbit/s

Important! If you have a multi-band router (e.g. 2.4 & 5 GHz), make sure your mobile device is connected to the 2.4 GHz network if you want to connect base station and app.

Requirements for your mobile device (smartphone or tablet)

Apple devices require at least iOS 9 or higher and Internet access via Wi-Fi or mobile data.
 Android devices require at least OS 5.0 or higher and Internet access via Wi-Fi or mobile data.

Service & Support

If you unexpectedly have problems with your station or the TFA VIEW App or if you would like to find out more about TFA Dostmann products, you will find all information and help directly on the following Internet pages:

TFA Dostmann customer service

www.tfa-dostmann.de/en/service/

Information about TFA Dostmann and other products

www.tfa-dostmann.de/en/

Important notes

Delivery contents

Projection alarm clock, power adapter for projection alarm clock, operating instructions, backup battery (1x CR 2032)

Before you use this product

Please make sure you read the quick setup guide carefully. Following and respecting the instructions in your manual will prevent damage to your instrument and loss of your statutory rights arising from defects due to incorrect use. We shall not be liable for any damage occurring as a result of non-following of these instructions. Likewise, we take no responsibility for any incorrect readings or for any consequences resulting from them.

Please pay particular attention to the safety notices! Please keep this instruction manual safe for future reference.

For your safety

This product should only be used as described within these instructions. Unauthorized repairs, alterations or changes to the products are prohibited.



Caution!
Risk of electrocution!

- Plug the base station only into a mains socket installed within your country's electrical safety regulations and with a correct mains voltage (see nameplate).
- The mains socket must be located near the equipment and it must be easily accessible.
- Unplug the device immediately if any fault occurs.
- The base station and the power adapter must not come into contact with water or moisture. Only suitable for indoor use.
- Do not use the device if the housing or the power adapter are damaged.
- Operate the device out of reach of persons (including children) who cannot fully appreciate the potential risks of handling electrical equipment.
- Only use the supplied power adapter.
- Route the mains cable so it does not come into contact with sharp-edged or hot objects.

! Important information on product safety!

- Do not expose the devices to extreme temperatures, vibrations or shocks. Protect from moisture!
- Clean the devices with a soft damp cloth. Do not use solvents or scouring agents.
- Remove the batteries from all devices if you do not use the products for a long period of time.
- Store the devices in a dry place.

Important notes



Caution!
Risk of injury:

- Keep these devices and the batteries out of reach of children.
- Batteries contain harmful acids and may be hazardous if swallowed. If a battery is swallowed, this can lead to serious internal burns and death within two hours. If you suspect a battery could have been swallowed or otherwise caught in the body, seek medical help immediately.
- Batteries must not be thrown into a fire, short-circuited, taken apart or recharged. Risk of explosion!
- Low batteries should be changed as soon as possible to prevent damage caused by leaking. Never use a combination of old and new batteries together, nor batteries of different types.
- Remove the batteries if the device will not be used for an extended period of time.
- Wear chemical-resistant protective gloves and safety glasses when handling leaking batteries.

Disposal

This product has been manufactured using high-grade materials and components which can be recycled and reused.



Never dispose of empty batteries and rechargeable batteries with ordinary household waste. As a consumer, you are required by law to take them to your retail store or to an appropriate collection site depending on national or local regulations in order to protect the environment. The symbols for the contained heavy metals are:
 Cd = cadmium, Hg = mercury, Pb = lead



This product is labelled in accordance with the EU Waste Electrical and Electronic Equipment Directive (WEEE). Please do not dispose of this product in ordinary household waste. As a consumer, you are required to take end-of-life devices to a designated collection point for the disposal of electrical and electronic equipment, in order to ensure environmentally-compatible disposal.

Hereby, TFA Dostmann declares that the radio equipment type 35.8002.01 is in compliance with Directive 2014/53/EU. The full text of the EU declaration of conformity is available at the following internet address: www.tfa-dostmann.de/service/downloads/ce

TFA Dostmann GmbH & Co.KG, Zum Ottersberg 12, 97877 Wertheim, Germany

Commercial registration number: Reg. Gericht Mannheim HRA 570186

No part of this manual may be reproduced without written consent of TFA Dostmann. The technical data are correct at the time of going to print and may change without prior notice.

For more information and a detailed description, go to www.tfa-dostmann.de/view/.